

**ACCESS  
CONTROL**

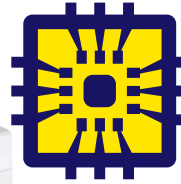

**DIGITAL  
VIDEO**



**APOLLO**  
intelligent security solutions



**BUILDING  
AUTOMATION**



*Your site security system is only as good as the information it provides. Why compromise when so much can be at stake? Be in control—know who goes where, what happens when and have a comprehensive overview after the fact. Monitor and control systems throughout your organization. Choose a system that is trusted by the most sensitive sites throughout the world. APACS is global mission critical.*

Apollo Security's Access Control and Alarm Monitoring System (APACS) is the result of years of research and design coupled with real-world input from security professionals working at the most secure sites around the globe. APACS comprises the basis for a flexible and robust system that meets the needs of systems ranging from perimeter systems up to fully integrated enterprise-level installations.

### **Integration**

Don't just manage Access Control, take charge of your entire security system. APACS supports a full range of Digital/Network Video Recorders (DVR/NVR) with a consolidated interface. APACS supports digital video products from Panasonic, Samsung, Pelco, Vicon, Verint and Milestone as well as ApolloVideo and ApolloVision products. A full featured OPC Client enables monitoring and control of building infrastructure and factory automation equipment.

### **Trusted High-Level Security**

In use at some of the most secure places around the world including military facilities, nuclear power plants and oil & gas industry installations, APACS has been proven time and time again. Taking control of security has never been easier with features like Windows Active Directory single sign-on, central storage of multiple biometric templates and easy enrollment of FIPS 201 credentials.

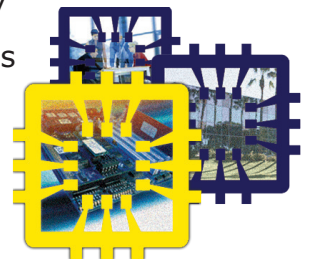

# Access & Alarm Monitoring

APACS gives site security personnel complete control and a comprehensive overview of the state of the system. Using the Alarm Mode console, staff can easily view access activity and alarm status in real-time. Customizable interactive maps can be configured to automatically display the highest priority events in the system so that guards can react with maximum efficiency. Advanced cardholder tracking allows location identification based on access activity. Automatic display of cardholder information at selected access points allows matching of credentials to information stored in the cardholder database. Independent station or operator based configuration allows varied tasks to be streamlined depending on the function of each guard station including partitioning of monitoring, restriction on controls and commands, or full screen map mode for control room status displays.

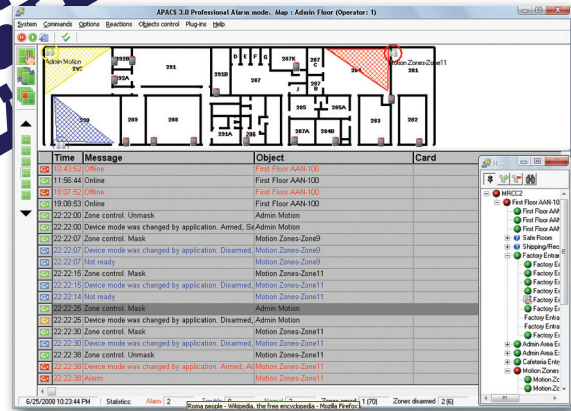

## Next Generation Hardware Support

APACS supports Apollo's newest hardware platform the ASP series, a next generation Network Clustering Integrated Controller. This new family of devices enables inter-device communication to form an intelligent cluster that coordinates access and manages other functions without connection to software. Providing a single path to host via a cluster master optimizes network traffic as well as having capability for hardware backup.

Apollo systems also support a range of other devices including input/output modules, elevator control interfaces, high security relay devices and more. Multiple reader technologies including Proximity, Biometric, Smart Card, Magnetic Stripe, OSDP Secure Channel as well as turnstile, barrier, man-trap, prison bolt locking systems are also supported.

## Human Resources

Don't just assign access to users, take control of your human resources and contractors by maintaining a fully configurable database of user data with customizable, searchable fields. Not only does the APACS system allow up to 50 native access levels per card, but Smart Downloading only loads cards to controllers where the card has access, allowing maximum memory utilization. Card issuing offices will also appreciate the full badging capabilities with an advanced card design facility. Assign multiple levels according to personnel and easily assign access levels according to group assignment. Keep a complete data record with up to 100 user-defined fields for each record that can be used for reports as well as searches. FIPS 201 card enrollment features allow reading of personal information from the card including name and photo in addition to card numbers (System, Site & Credential). Support for easy enrollment methods such as driver's license and passport scanners.

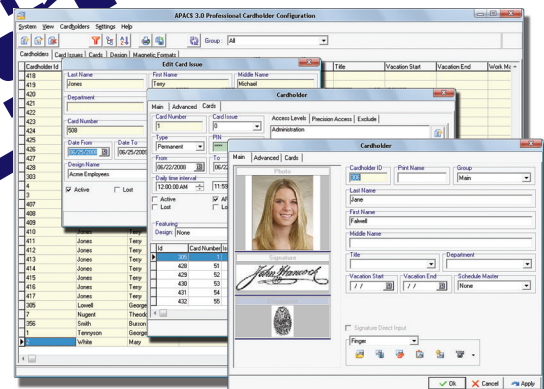



# Enterprise Features

## Digital Video Integration

The APACS Universal Video Interface provides a common configuration and viewing interface for all supported DVR/NVRs. Viewing and control from monitoring station maps and video retrieval from events on monitoring and reporting stations. Support for a wide range including Salient, Hikvision, Panasonic, Bosch, Samsung, Verint, Vicon, Pelco and Milestone products.

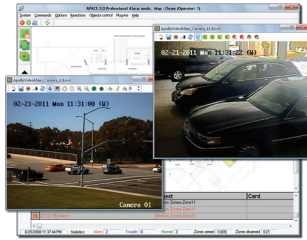

## Web Interface & Android Mobile Reader

Browser based client for desktop, tablet or mobile provides reporting, control, monitoring and card management without installing software. User customizable web dashboard with grids and charts for system analysis. Android Mobile Reader application provides verification, access and time and attendance functions.

## Visitor Management

Visitor tracking with web interface including pre-registration, full appointment display, escort control per reader and pre-configured reports for an easy overview of guests at your facility. Optional interface for Easy Lobby™ Visitor Management software.

## Advanced Biometric Support

Storage of multiple biometric templates in APACS database with automatic downloading to fingerprint and hand geometry readers. Easy enrollment of users from any badging station. Support for Suprema, Morpho Sigma, Bioscrypt/L1, and Schlage biometric readers.

## Global Anti-Passback & Mustering

Full global anti-passback area control including maximum/minimum occupancy, open/close, manual movement by operator, nested areas, hardware reactions by occupancy and instantaneous as well as historical reports. Mustering features for hazardous and safe area control to easily manage evacuation during emergency situations

## Apollo System Highlights

- Full featured reporting including pre-configured reports for Visitor Management and Employee Attendance.
- 256-bit AES encryption protects all network data communication and database passwords, IPv6 Support
- Support for Microsoft SQL Server, Oracle Databases.
- SMTP support for email notification of system events.
- OPC Alarms/Events Client for sending custom messages to APACS from sensor hardware. Writing of OPC Data for control systems.
- Single Sign-on compatible with Windows Active Directory
- Webservices API allows third party interface for events, cards, control and event stream
- High Level Interface for Otis, Kone and Tyssen elevator systems
- Use Limit to control number of times a card is used before expired
- Threat Level to lock down sites during alert situations

## Powerful Badging Routine

Full-featured integrated badge design module features advanced photo manipulation including batch image processing and automatic conversion/modification. Multiple card designs per card holder, barcode and mag card encoding.



Advanced Features

## System Requirements

	Database/Hardware Server	Client Station (Monitoring, Badging)
Processor	Intel Core i7 (10th generation)	Intel Core i3 (10th generation)
Memory	16 GB (minimum)	8 GB (minimum)
Hard Drive (min. free space)	256 GB (SSD Recommended)	128 GB (SSD Recommended)
Network Card	Gigabit Ethernet	Gigabit Ethernet
Graphics card	16 MB Memory XGA	Dedicated video card recommended when APACS Video Integration feature is enabled.
Database	MS SQL Server Express (included), MS SQL Server 2017, 2019	MS SQL Server Express (included), MS SQL Server 2017, 2019
Operating System	Microsoft Windows 11, 10, 8.1, 8, Pro-Ult-Ent Windows Server 2008 R2, 2012, 2012 R2, 2016, 2019	Microsoft Windows 11, 10, 8.1, 8, Pro-Ult-Ent Windows Server 2008 R2, 2012, 2012 R2, 2016, 2019
Other	Keyboard & Mouse, 1 Serial Port, 1 USB Port, External periodic backup device (NAS or USB HDD)	Keyboard & Mouse, 1 Serial Port, 1 USB Port

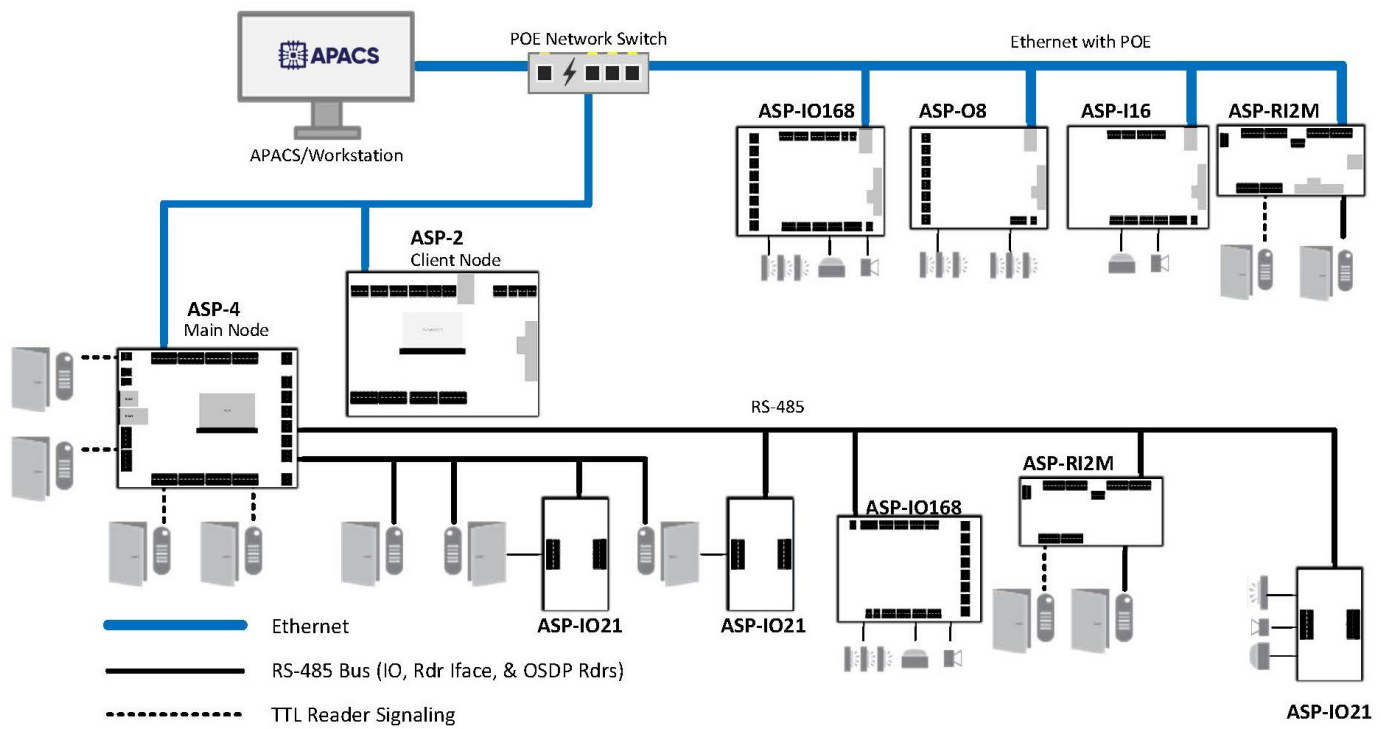
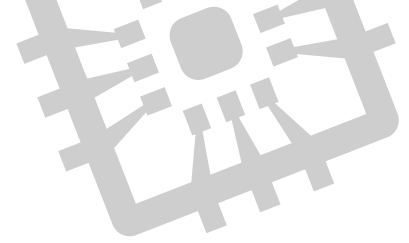

## APACS Pro

Comprises an advanced security management software package. Integrates access control with digital and analog video equipment, visitor management systems, HVAC and lighting control systems, public address and paging systems. APACS Pro's Reaction mechanism provides a powerful programming interface for unlimited integration possibilities. Includes all features of APACS Standard.

- DVR/CCTV Control
- HVAC & Building Control via OPC
- Reaction/Message Mask Mechanism for advanced software control of hardware and software
- Customized graphic displays according to actual hardware status
- Live Video Verification
- Access Level assignment automatic by Cardholder Group

## APACS Standard

Full featured system control with the added capability of displaying events and state of hardware on interactive graphical maps at the guard station. For easy card issuing, full featured badge design and magnetic card encoding. Full featured Guard Tour using existing system objects.

- Customized interactive graphic maps with user created icons, permissions and storage formats
- Full featured badge design module with advanced photographic manipulation
- Real-time visitor status tracking
- Global Anti-Passback and Hazardous Area Mustering Management
- One-click video retrieval in reports
- Biometric Template Support

- PROGRAM UPDATES - Version 3.9**
- Support for ASP hardware devices with OSDP Secure Channel
  - Support for Elevator HLI
  - Webservices API
  - APACS Web Client
  - Enhanced support for FIPS credentials
  - Threat Level, Use Limit, Sabbath mode for ASP
  - Assign access by strike relay or area

3610 Birch Street  
 Newport Beach, CA 92660-2619, USA  
 Tel: +1 949 852 8178 Fax: +1 949 852 8172  
 www.apollo-security.com

